

PRINCIPLES OF LOW FLOW DRIP IRRIGATION AND TRENDS IN THE INDUSTRY

Michael Esmeraldo

Agronomist



AGENDA

- Introduction
- Background of drip on Avo's
- Modern day drip irrigation
- Maintenance challenges
- New tendencies
- Conclusions



INTRODUCTION

As the world's population continues to rise and natural resources come under pressure, to be more efficient with all our resources makes more sense than ever.

As Netafim, we help our customers to produce more yields and healthier crops with fewer resources.

"Grow more, with less"



SOME THINGS TO THINK ABOUT.....



COMMON REMARKS ABOUT DRIP ON AVO'S

- **Farmer X : “Avo’s root system is too shallow for drip irrigation”**
- **Expert Y : “Drip does not work on clay soils”**
- **Designer Z: “ With drip irrigation I don’t fully benefit from the rain, because my root system is to concentrated”**



A BRIEF HISTORY

- **Probably the biggest flaw with drip irrigation was mismanagement in the past.**
- **Leaching of water and nutrients past the root zone was a common problem.**
- **North vs South**
- **Internal and external factors forcing producers to adapt quickly**
- **Use the resources you have to better effect**



ANSWERS

Why is an Avo's root system too shallow for drip?

= It was not prepared deep enough and no ridge was built

Why does drip not work on a heavy clay soil?

= It was not prepared deep enough and no ridge was built

Why does drip irrigation concentrate my roots so that they can't use the rain water effectively?

= The soil was not well prepared and now the roots can't grow freely, they stay concentrated in the small drip reservoir



SOIL PREPARATION = ROOTZONE

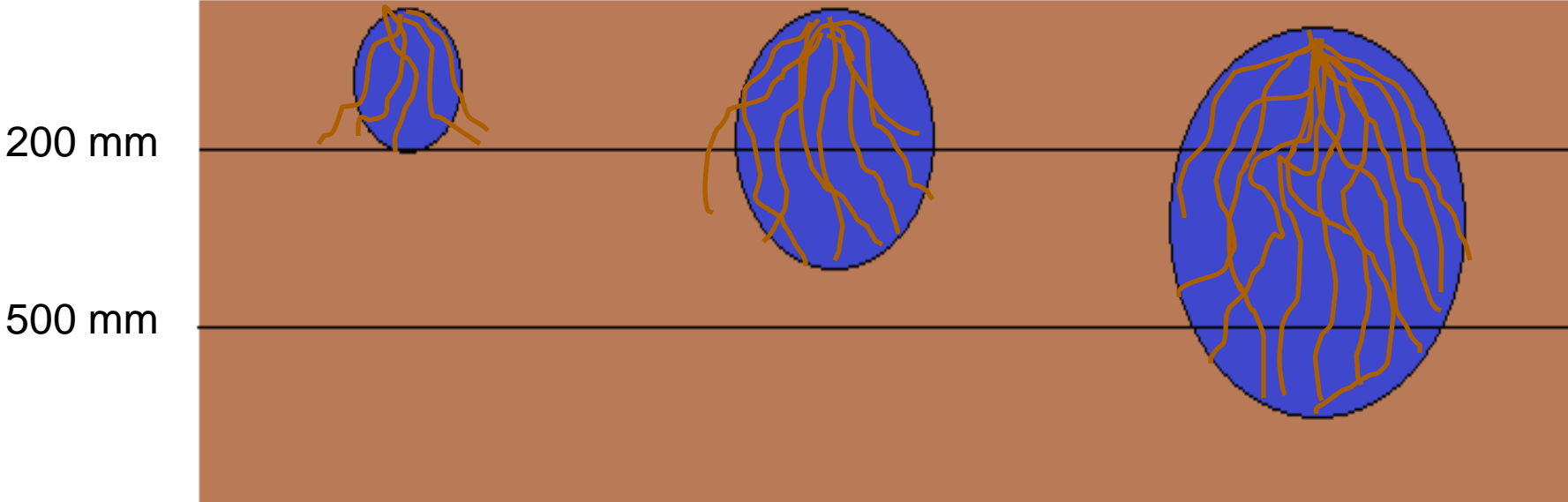

ROOT SYSTEMS - MICRO



ROOT SYSTEMS - MICRO



GE



ROOT SYSTEMS - DRIP



ROOT SYSTEMS - DRIP



A photograph of an olive grove with rows of trees. The ground is covered in dark brown soil and mulch. Black drip irrigation lines are visible running along the base of the trees. The trees have green leaves and some small white flowers.

MODERN DAY DRIP IRRIGATION

50
YEARS
OF SHAPING
THE FUTURE

NETAFIM™

DRIP IRRIGATION

- Drip irrigation is all about efficiency
 - Efficient uptake of water by the roots
 - Efficient uptake of nutrients by the roots
 - In other words not wasting any water and nutrients = saving costs
- Reducing the **E** component in ET_0

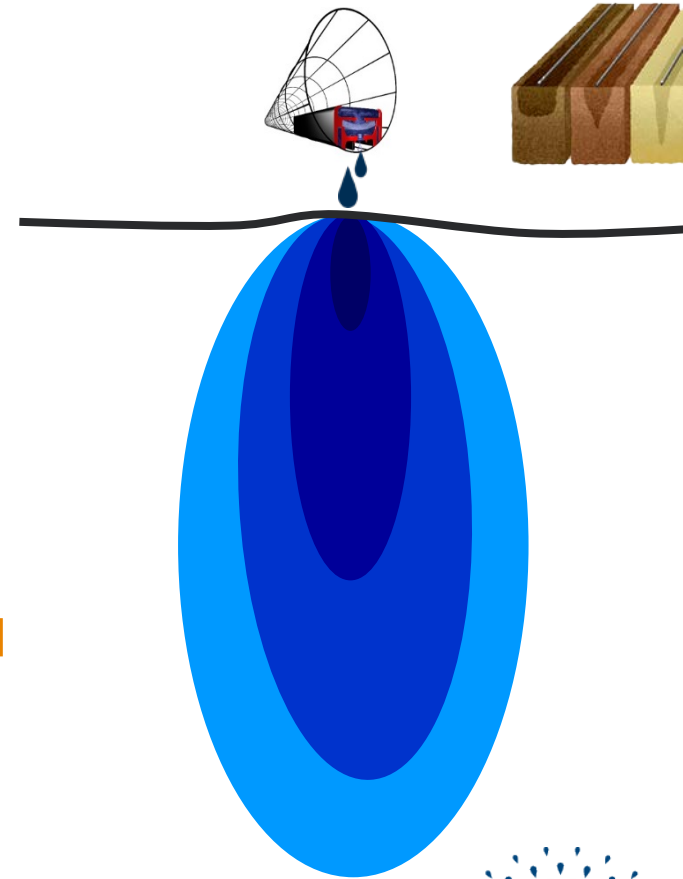

Evapotranspiration

E vaporation + **T** ranspiration

= Evapotranspiration

$Kc \times ET_0 = \text{Water requirement (mm/day)}$

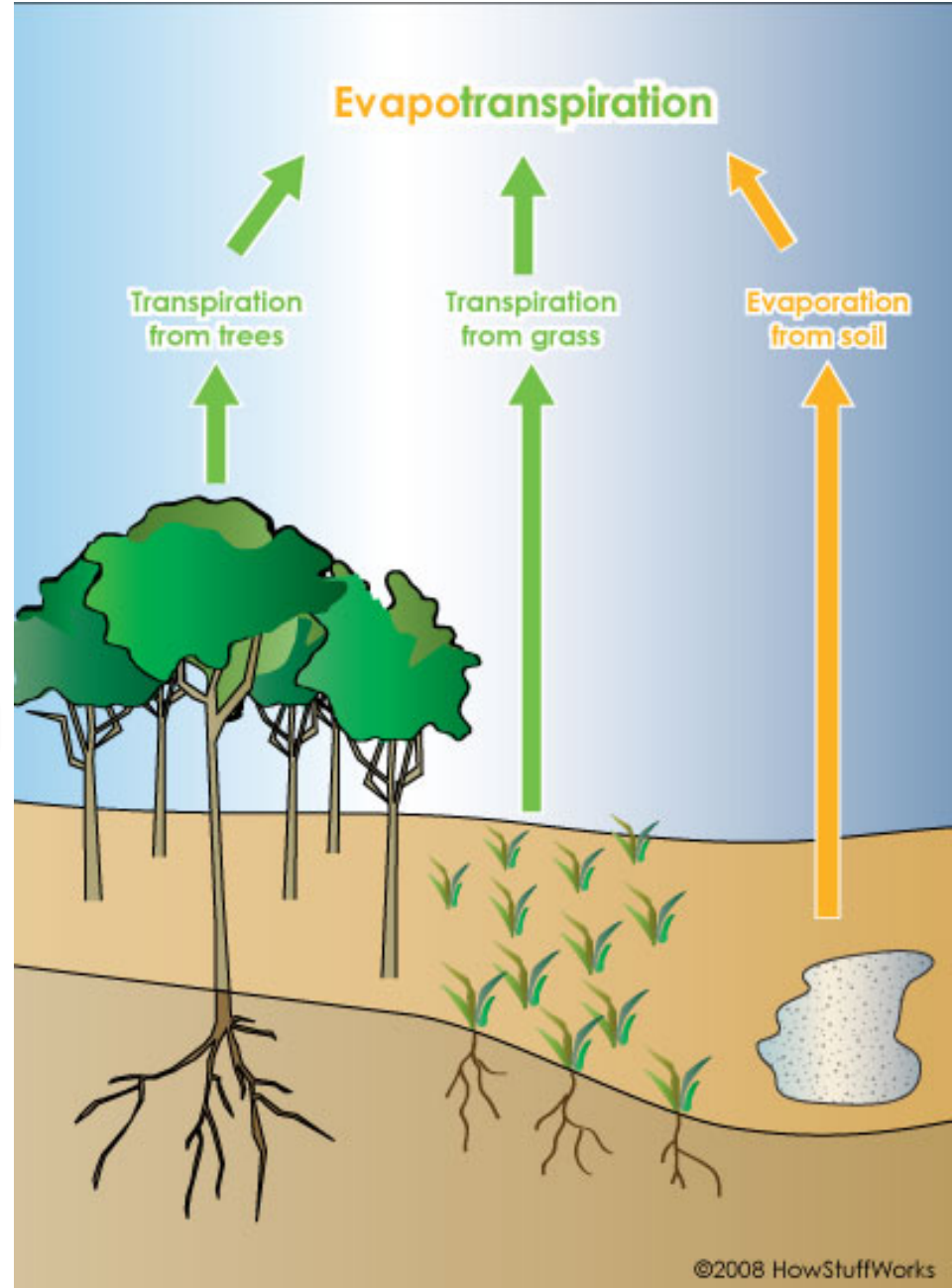

©2008 HowStuffWorks



VARIOUS DRIP APPROACHES

❖ Strip



❖ Pots



❖ “Continuous drip irrigation”

Traditional drip concepts

NEW

50
YEARS
SHAPING
THE FUTURE

NETAFIM™

CONTINUOUS DRIP IRRIGATION

Continuous drip irrigation: Balance application rate of irrigation system with the maximum daily water use over the total consumptive period of the crop.

Try to keep the tree as close to 100% happy as we can.

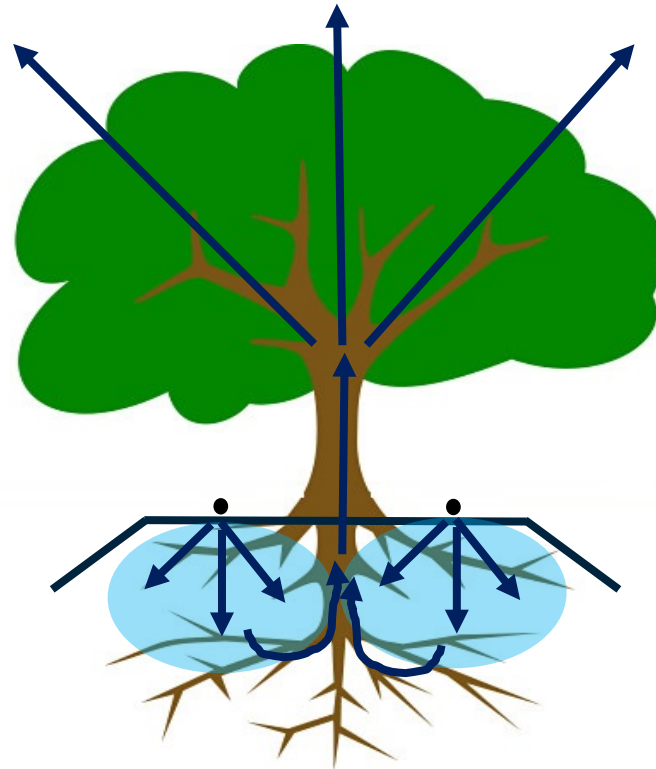

Continuous Low flow Drip Irrigation

- Flow of 2.5 – 3.5 m³/h/ha
- 1 shift can irrigate the whole farm at once
- Delivery rate : 0.7ℓ/h or 1.0ℓ/h (Uniram™ RC)
- Spacing of emitters : 0.8 m – 1.2 m
- Design the system to deliver the water over 12 – 14 hours
- Can always use the night as supplementary irrigation time



Irrigation: Off

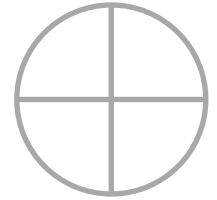

A

12 m³/h/ha
30 ha per shift

Shifts

1	3
2	4

Q = 0 m³/h

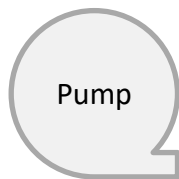

B

6 m³/h/ha
60 ha per shift

1	2
---	---

Q = 0 m³/h

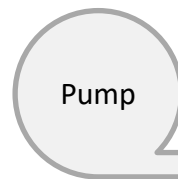

C

3 m³/h/ha
120 ha per shift

1

Q = 0 m³/h

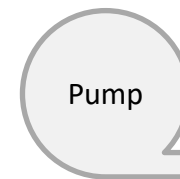

Irrigation On: 06h00 – 09h00

[3 hours]

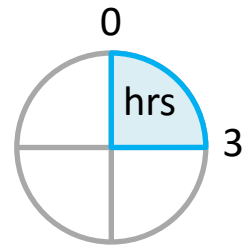

A

12 m³/h/ha
30 ha per shift

3 hours	3
2	4

Q = 360 m³/h

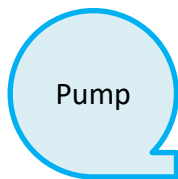

B

6 m³/h/ha
60 ha per shift

3 hours	2
------------	---

Q = 360 m³/h

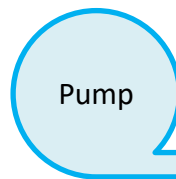

C

3 m³/h/ha
120 ha per shift

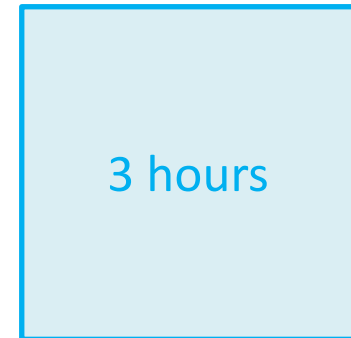

Q = 360 m³/h

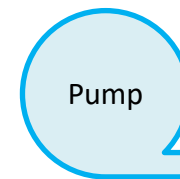

Irrigation On: 09h00 – 12h00

[3 hours]



A

12 m³/h/ha
30 ha per shift

3 hours	3
3 hours	4

Q = 360 m³/h

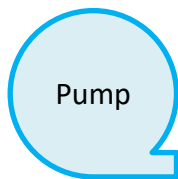

B

6 m³/h/ha
60 ha per shift

3 + 3 hours	2
-------------	---

Q = 360 m³/h

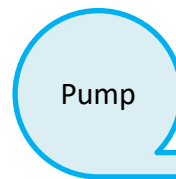

C

3 m³/h/ha
120 ha per shift

3 + 3 hours

Q = 360 m³/h

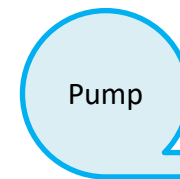

Irrigation On: 12h00 – 15h00

[3 hours]

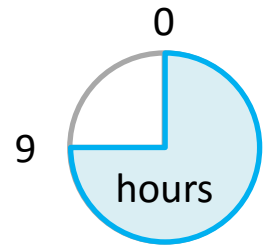

A

12 m³/h/ha
30 ha per shift

3 hours	3 hours
3 hours	4

Q = 360 m³/h

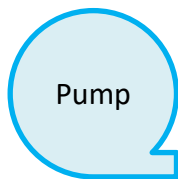

B

6 m³/h/ha
60 ha per shift

6 hours	3 hours
---------	---------

Q = 360 m³/h

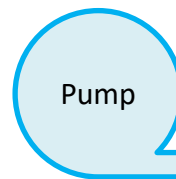

C

3 m³/h/ha
120 ha per shift

3 + 3 + 3 hours

Q = 360 m³/h

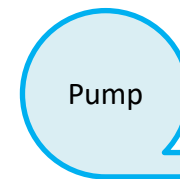

Irrigation On: 15h00 – 18h00

[3 hours]



A

12 m³/h/ha
30 ha per shift

3 hours	3 hours
3 hours	3 hours

Q = 360 m³/h

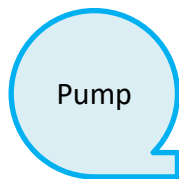

B

6 m³/h/ha
60 ha per shift

6 hours	3 + 3 hours
------------	----------------

Q = 360 m³/h

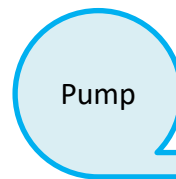

C

3 m³/h/ha
120 ha per shift

3 + 3 + 3 + 3 hours

Q = 360 m³/h

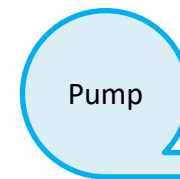

Irrigation: Switch Off after 12 hours

A

12 m³/h/ha
30 ha per shift

3 hours	3 hours
3 hours	3 hours

12 m³/h/ha
x 3 h/shift
= **36 m³ / day**
= **3.6 mm/day**

B

6 m³/h/ha
60 ha per shift

6 hours	6 hours
------------	------------

6 m³/h/ha
x 6 h/shift
= **36 m³ / day**
= **3.6 mm/day**

C

3 m³/h/ha
120 ha per shift

12 hours

3 m³/h/ha
x 12 h/shift
= **36 m³ / day**
= **3.6 mm/day**



CONTINUOUS IRRIGATION

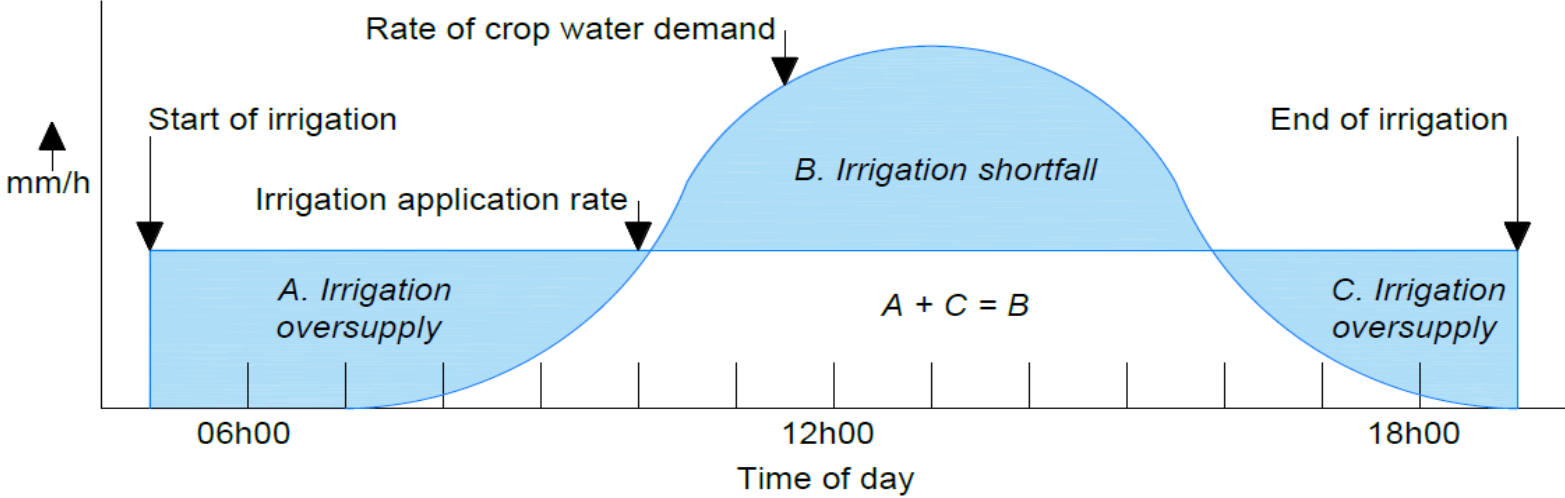

FIGURE 12. Crop water demand v irrigation application rate



CONTINUOUS DRIP VS TRADITIONAL DRIP

- 1 shift irrigates **whole** farm
 - Flow rate = 2.5-3.5 m³/ha
 - Delivery rate = 0.7 – 1.0 l/h
 - Continuous supply of water
 - Less labour/controllers in field
 - Easy to manage
- 2 – 4 shifts on the farm
 - Flow rate 5-14 m³/ha
 - 1.6 – 2.3 l/h
 - Dumping the water in a few hours
 - More labour/controllers in field
 - More challenging to manage

Both will work it is just a question
of which one will work for you?





MAINTENANCE

Possible Causes of Blockages

- Physical
 - Organic material
 - Leaves & Twigs
- Chemical
 - Carbonates, iron, manganese, fertilizers
- Biological
 - Bacteria, slimes, etc



SOLUTIONS TO THE CHALLENGES

You
don't have
to 
BRUSH ALL YOUR TEETH—
Just the ones you want to keep.



Posted at
BAJIROO.COM



Treatments - Flushing

- This is the single most important point for drip maintenance.
- Always make provision to flush mainlines, sub-mainlines and dripperlines.
- It is better to remove any dirt before it enter the dripperlines.



Chemical Treatments

- Acid
 - Salt or carbonate deposits
- Hydrogen Peroxide
 - Bacteria, slime and algae
- Combination:
- (Acid then Hydrogen Peroxide)
 - Iron and or Manganese bacteria



SOLUTIONS





New Tendencies

NEW TENDENCIES



50
YEARS
SHAPING
THE FUTURE



NEW TENDENCIES



CENTRAL PUMP HOUSE CONTROL

- Every block has its own dedicated mainline
- No need for valves in the field
- Every block can get its own personal fertilizer
- From the pump house everything can be controlled

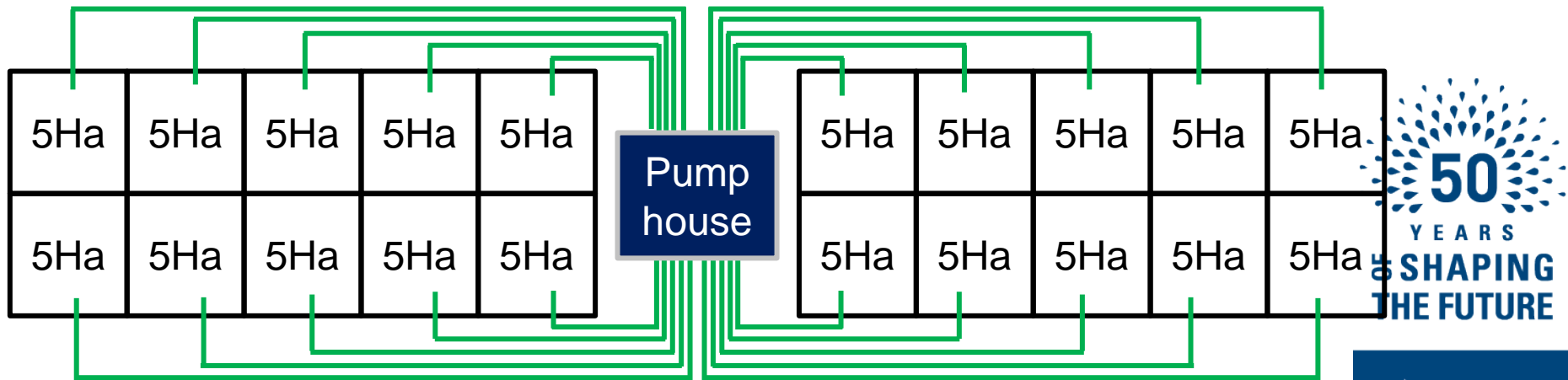

NEW TENDENCIES



NEW TENDENCIES





CONCLUSIONS

Drip Irrigation → Delivery System

First Generation

Deliver:

- Water only

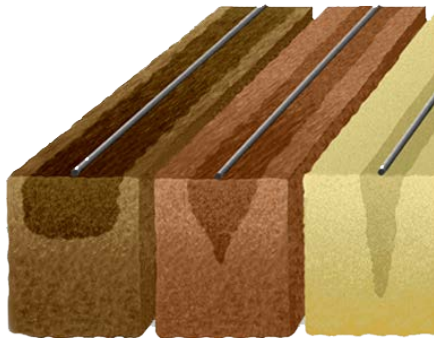
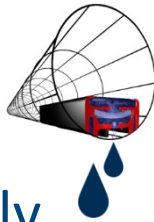

Second Generation

Deliver:

- Water
- Fertilizers



- N
- P
- K

Nutrigation™

Third Generation

Deliver:

- Water
- Fertilizers
- Chemicals
- Biological
- Physiological
- Other



CONCLUSIONS

- We understand the issues in the past, we have worked hard to find solutions for them
- Soil preparation and ridging are absolutely critical factors to ensure optimal conditions for crop production
- Continuous drip irrigation is a new concept with a lot of advantages for the tree's as well as the producer
- There is effective ways to clean your drip system – don't be scared, be prepared
- Dedicated mainlines offer more control in field

***Save water, save money and grow more
with less***



Thank
you

